

REACH & RoHS
COMPLIANT

REV.	ECN / DESCRIPTION	BY	DATE
A0	NEW	TW.Xu	2018.11.24

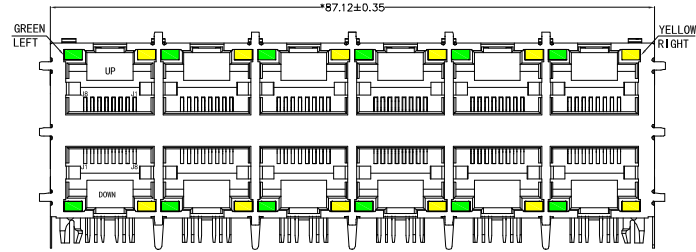

FRONT VIEW

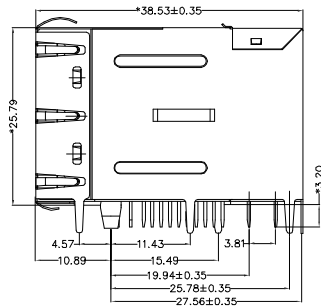

RIGHT SIDE VIEW

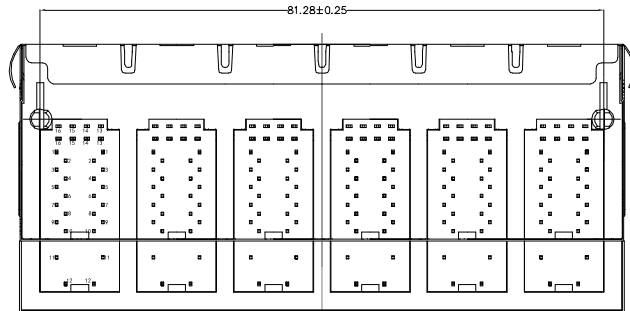

BOTTOM VIEW

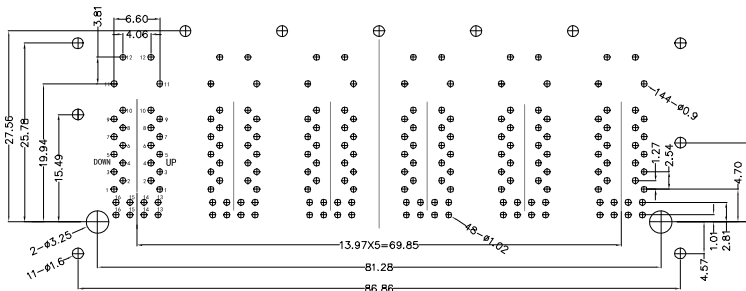

RECOMMENDED PCB LAYOUT
VIEWED FROM COMPONENT SIDE

MATERIAL:

HOUSING: PBT,UL94V-0,BLACK.
TERMINALS BRACKET: PBT,UL94V-0,BLACK.
SHIELD: C2680,T=0.20MM,NICKEL PLATING ON ALL AREA.
TERMINAL: PHOSPHOR BRONZE C5210,T=0.35MM,
6U" GOLD PLATING ON CONTACT AREA.

MECHANICAL:

DURABILITY: 750 CYCLES MIN.
MATING FORCE: 23N MAX.
OPERATING TEMPERATURE: -40°C~+85°C.
STORAGE TEMPERATURE: -40°C~+85°C.
ALL CRITICAL DIMENSIONS WITH "±"

 东莞市涪程电子科技有限公司
DONG GUAN FU CHENG ELECTRONIC TECHNOLOGY Co., LTD

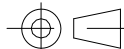
TITLE: RJ45 2X6 1000BASE POE	SIZE A4	UNITS MM[INCH]	GENERAL TOLERANCES UNLESS SPECIFIED		APPROVED BY: JP.Gong
PART NO.: FCRJ45-26Q248DB2A4DP068	SACLE 1:1	REV A0	x±0.35	x°±3.0°	CHECKED BY: TW.Xu
REMARK:	SHEET 1/3		.x±0.30	.x°±2.0°	DESIGND BY: TW.Xu
			.xx±0.25	.xx°±1.5°	
			.xxx±0.10	.xxx°±1.0°	

REACH & RoHS
COMPLIANT

REV.	ECN / DESCRIPTION	BY	DATE
A0	NEW	TW.Xu	2018.11.24

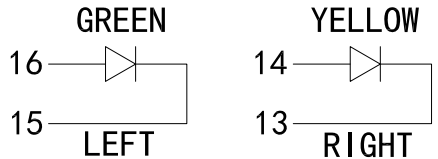
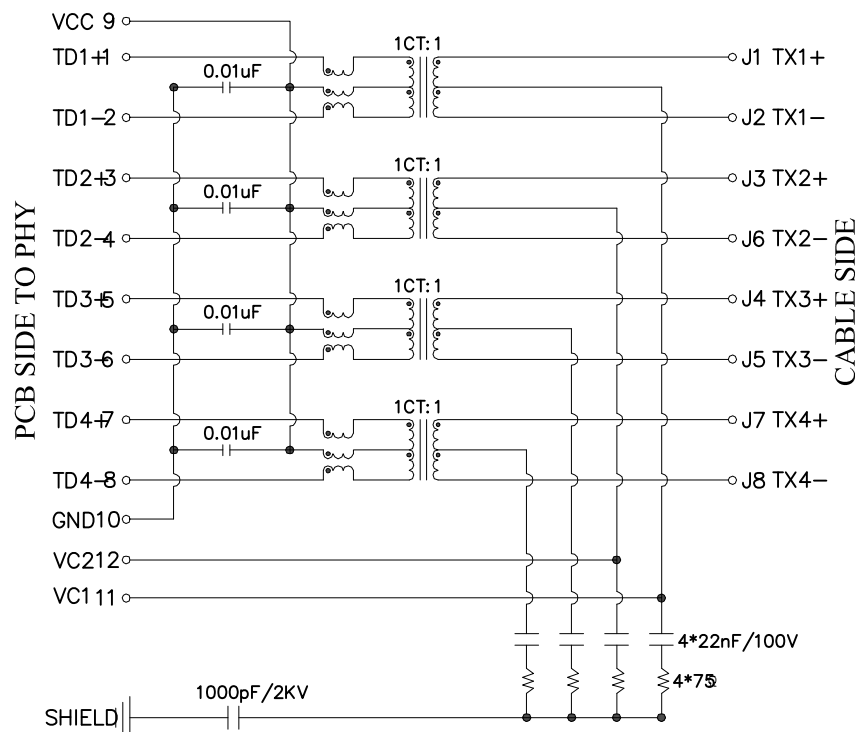

Electrical:

- Turn ratio: 1~2: J1~J2=1CT:1CT(±2%).
3~4: J3~J6=1CT:1CT(±2%).
5~6: J4~J5=1CT:1CT(±2%).
7~8: J7~J8=1CT:1CT(±2%).
- OCL: 350uH Min. @ 100KHz 100mV
RMS(4Channel) 8mA DC BIAS.
- Insertion Loss: -1.0 dB Max 1~100MHz.
- Return loss: -20dB Min 1~10MHz;
-16dB Min 10~30MHz.
-12dB Min 30~60MHz.
-10dB Min 60~80MHz.
- Cross talk: -40dB Min 1~30MHz;
-35dB Min 30~60MHz;
-30dB Min 60~100MHz;
- CMR: -30dB Min 1~100MHz;
- Hi-Pot: 2250V DC 6S 1mA MLCC
- Gigabit single port magnetic jack POE magnetics acc.
To IEEE802.3af for PSE or PD applications.
- 100% of production tested to comply with
IEEE 802.3 isolation requirements balanced DC
line current 720mA max. @57V DC continuous.

LED Specification

Standard LED Color	LED Wavelength	Foward(A)	Foward(V)
Green	568nm	20mA	1.85-2.45V
Yellow	585nm	20mA	1.7-2.2V

 东莞市涪程电子科技有限公司
DONG GUAN FU CHENG ELECTRONIC TECHNOLOGY Co., LTD

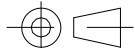
TITLE: RJ45 2X6 1000BASE POE	SIZE A4	UNITS MM[INCH]	GENERAL TOLERANCES UNLESS SPECIFIED		APPROVED BY: JP.Gong
PART NO.: FCRJ45-26Q248DB2A4DP068	SACLE 1:1	REV A0	x±0.35	x°±3.0°	CHECKED BY: TW.Xu
REMARK:	SHEET 1/3		.xx±0.25	.xx°±1.5°	DESIGND BY: TW.Xu
			.xxx±0.10	.xxx°±1.0°	

REACH & RoHS
COMPLIANT

PROFILE OF WAVE SOLDER

REV.	ECN / DESCRIPTION	BY	DATE
A0	NEW	TW.Xu	2018.11.24

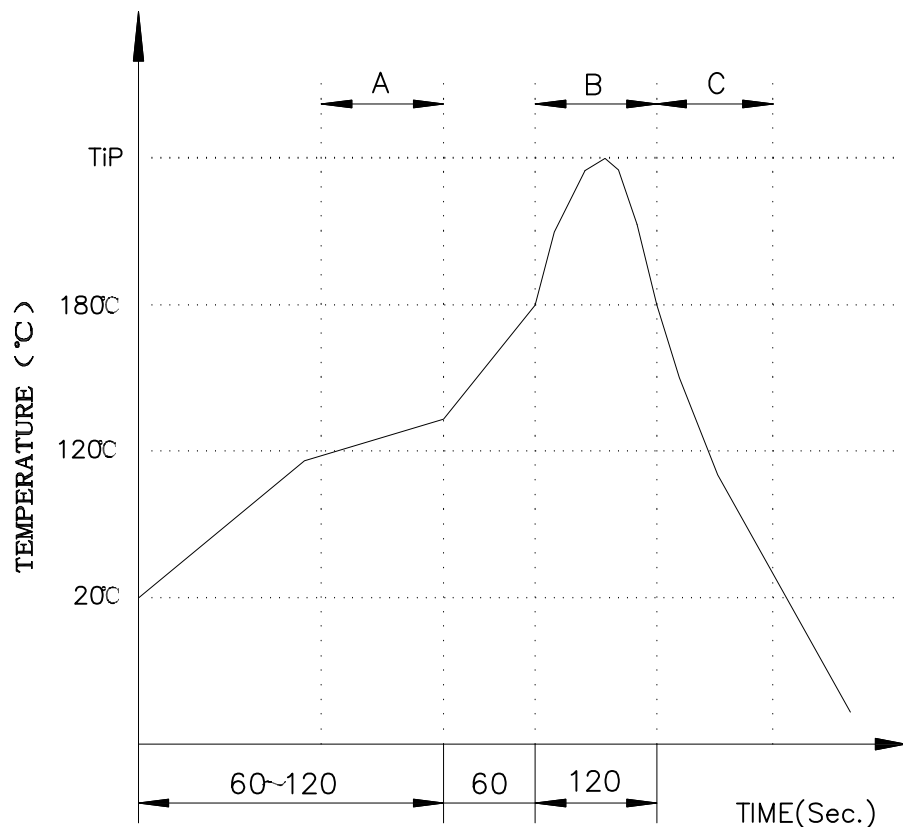

A.Preheating B.Soldering C.Gradual Cooling
 Tip temperature:260±5°C.
 Tip temperature time:5Sec Max.
 Tip melting point of Sn96.5/Ag3/Cu0.5:217°C.

Remarks: after wave soldering, the plastic positioning columns
 of the product which under the PCB will be slightly melted,
 but it won't affect its function .

 东莞市涪程电子科技有限公司
 DONG GUAN FU CHENG ELECTRONIC TECHNOLOGY Co., LTD

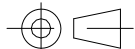
TITLE: RJ45 2X6 1000BASE POE	SIZE A4	UNITS MM[INCH]	GENERAL TOLERANCES UNLESS SPECIFIED		APPROVED BY: JP.Gong
PART NO.: FCRJ45-26Q248DB2A4DP068	SACLE 1:1	REV A0	x±0.35	x°±3.0°	CHECKED BY: TW.Xu
REMARK:	SHEET 1/3		.xx±0.25	.xx°±1.5°	DESIGND BY: TW.Xu
			.xxx±0.10	.xxx°±1.0°	