

ROSH

REV.	DESCRIPTION	APPD	DATE

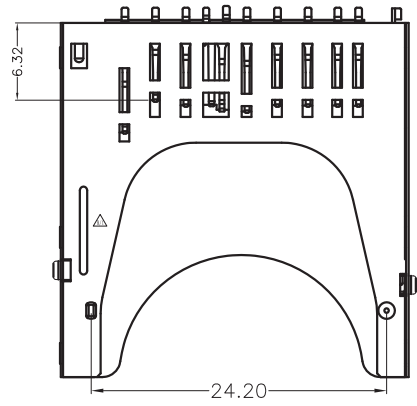
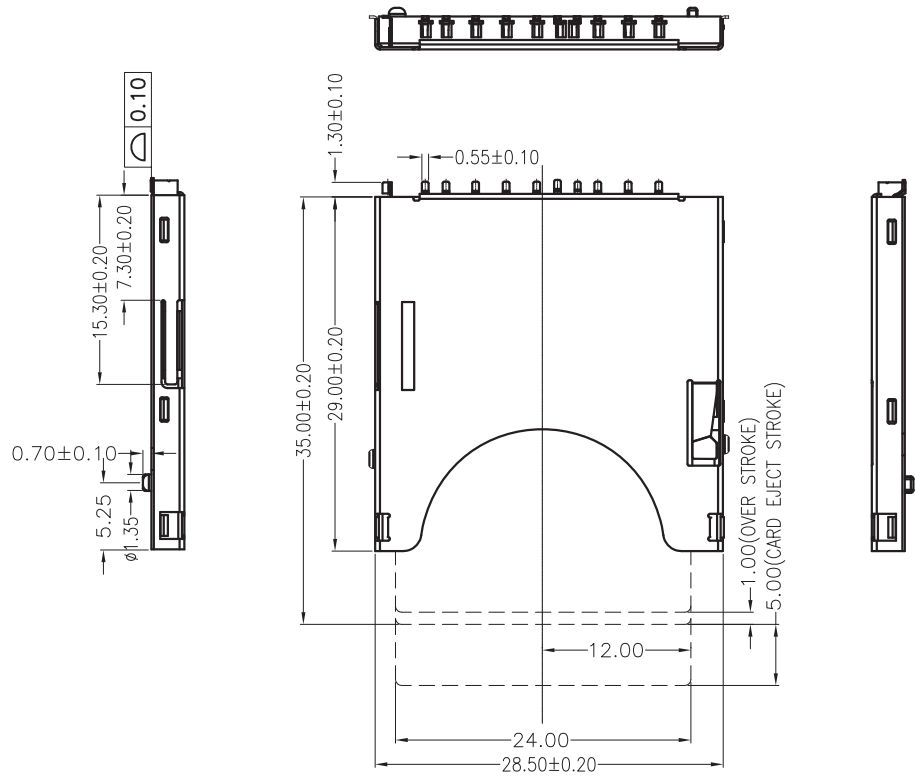

NOTES:

- MATERIAL:
HOUSING: HIGH TEMPERATURE THERMOPLASTIC UL94V_0,COLOR:BLACK.
CONTACT: COPPER ALLOYS.
COVER: COPPER ALLOYS OR STEEL.
- PLATING:
UNDERPLATE: NICKEL.
CONTACT AREA: GOLD OVER NICKEL.
SOLDER AREA: TIN OVER NICKEL.
- MULTIMEDIA CARD COMPATIBLE

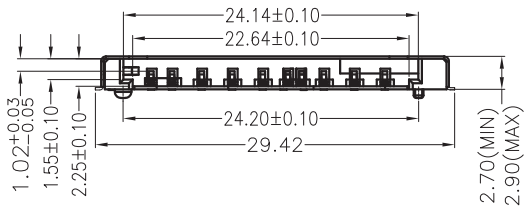
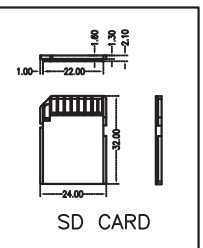

PART NO: SDPF3-EBS1-1311		MATERIAL:		东莞市涪程电子科技有限公司	
LOT NO: 1142200110		FINSH:			
UNIT: MM	SIZE: A4	COLOR:		TITLE: SD PUSH卡座 (E TYPE)	
TOLERANCES: X.X=±0.35 X.XX=±0.25 X.XXX=±0.15		GENERAL ANGLE: X.X=±5.0° X.XX=±3.0°		DR: 杨凯 08/26/08	DWG NO: FP-090015
APP:		SCALE: 1:1		SHEET: 1 OF 3	REV: B/2

ROSH

REV.	DESCRIPTION	APPD	DATE

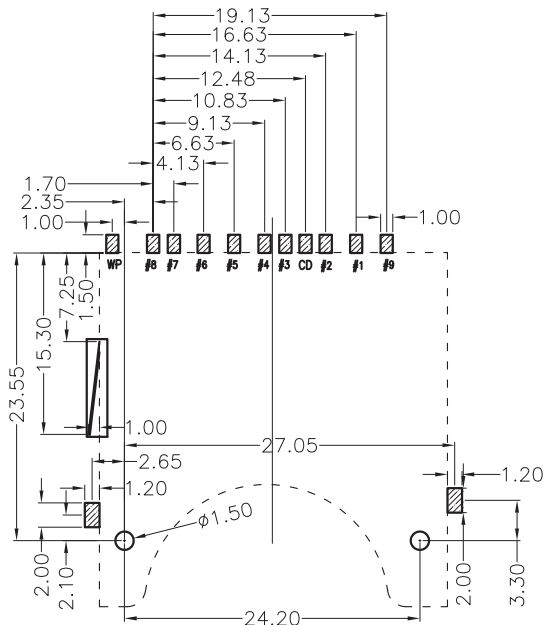

SD CARD PIN DESIGN			
PIN NO.	NAME	TYPE	DESCRIPTION
#1	CD/DAT3	I/O/PP	CARD DETECT/DATA LINE(BIT3)
#2	CMD	PP	COMMAND/RESPONSE
#3	VSS1	S	SUPPLY VOLTAGE GROUND
#4	VDD	S	SUPPLY VOLTAGE
#5	CLK	I	CLOCK
#6	VSS2	S	SUPPLY VOLTAGE GROUND
#7	DAT0	I/O/PP	DATA LINE(BIT 0)
#8	DAT1	I/O/PP	DATA LINE(BIT 1)
#9	DAT2	I/O/PP	DATA LINE(BIT 2)

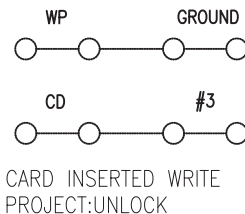
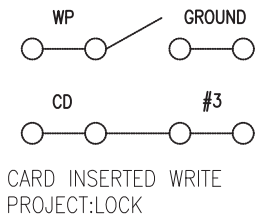
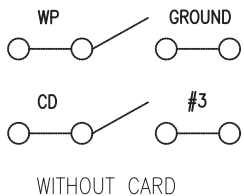

PART NO: SDPF3-EBS1-131X		MATERIAL:		东莞市涪程电子科技有限公司	
LOT NO: X1XX100110		FINSH:			
UNIT: MM	SIZE: A4	COLOR:		TITLE: SD PUSH卡座 (E TYPE)	
TOLERANCES: X.X=±0.35 X.XX=±0.25 X.XXX=±0.15		GENERAL ANGLE: X.X=±5.0° X.XX=±3.0°		DR: 杨凯 08/26/09	DWG NO: FP-090015
APP:		CHK:		REV: B/2	SCALE: 1:1
				SHEET: 2 OF 3	

ROSH

REV.	DESCRIPTION	APPD	DATE

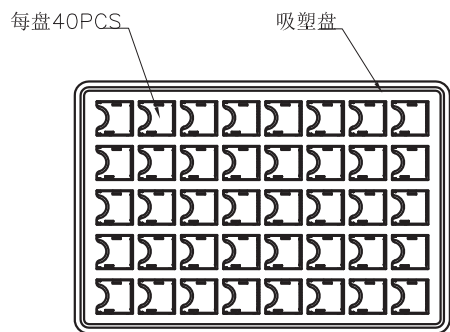

吸塑盘规格: 320*215*10

NO. 1

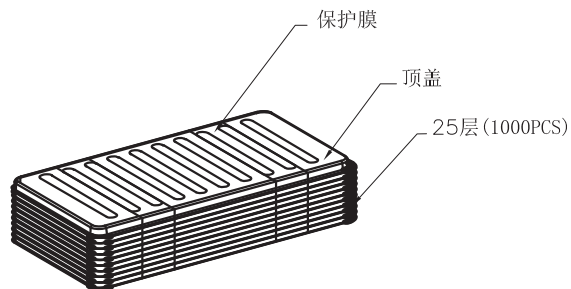

NO. 2

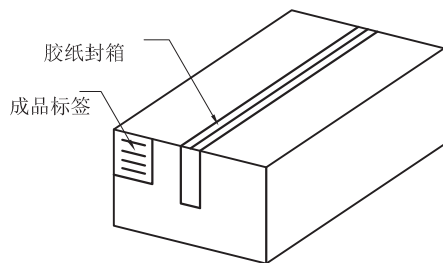

纸箱规格: 340*240*150

NO. 4

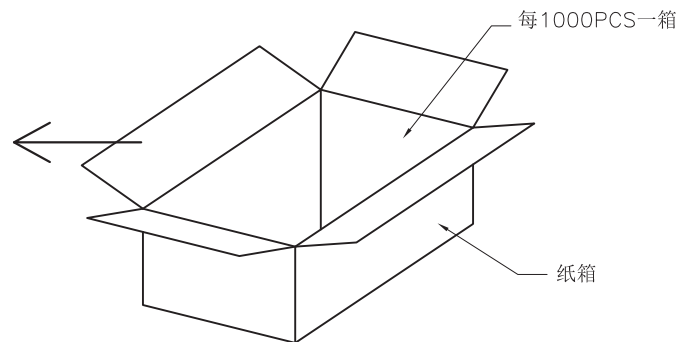

NO. 3

1. 材质要求:
 - 1.1 纸箱的材质为B=B; 外形尺寸为34*24*15CM;
 - 1.2 PS盘的材质为PS, PS盘的外形尺寸320*215*10MM;
2. 包装要求:
 - 2.1 每一盘装40PCS;
 - 2.2 每25盘累叠在一起, 共计1Kset; 上面需放一个空盘, 后用PE膜缠绕;
 - 2.3 把累叠好的PS盘放入纸箱中;
 - 2.4 把包装好的成品打包封箱, 并在纸箱中贴上标签;

PART NO: SDPF3-EBS1-131X		MATERIAL:		东莞市涪程电子科技有限公司	
LOT NO: X1XX100110		FINSH:			
UNIT: MM	SIZE: A4	COLOR:		TITLE: SD PUSH卡座 (E TYPE)	
TOLERANCES: X.X=±0.35 X.XX=±0.25 X.XXX=±0.15		GENERAL ANGLE: X.X=±5.0° X.XX=±3.0°		DR: 杨凯 08/26/09	DWG NO: FP-090015
				CHK:	
				APP:	SCALE: 1:1
				SHEET: 3 OF 3	

