

REACH & RoHS COMPLIANT

1. MECHANICAL DIMENSIONS :

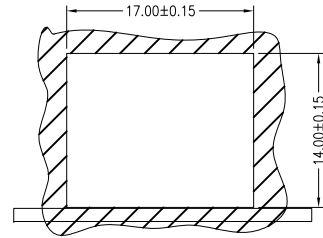

RECOMMENDED PANEL OPENING

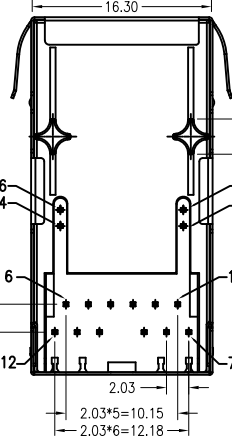
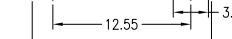
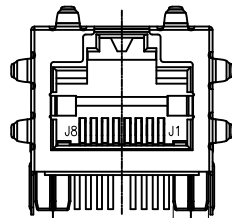
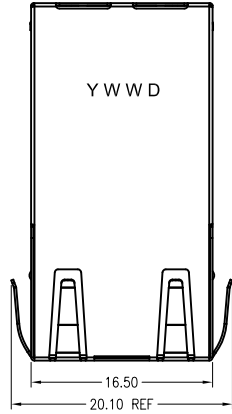
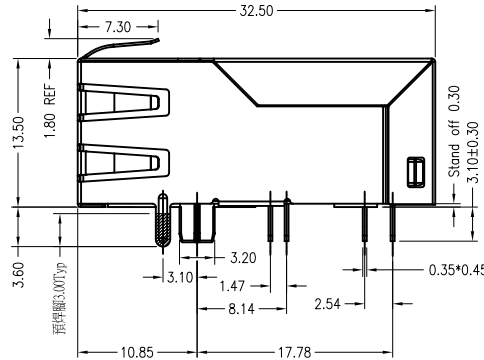

REV.	ECN / DESCRIPTION	BY	DATE
A0	NEW	MQ.Qu	2018.05.21

2. PCB LAYOUT :

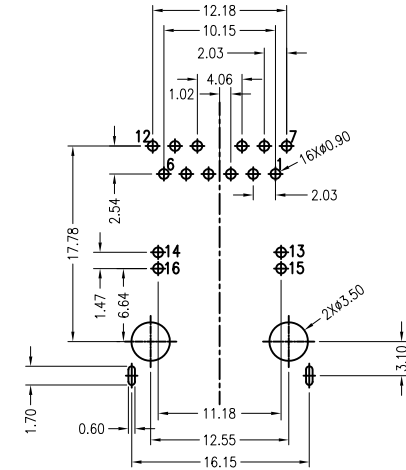

SUGGESTED PCB LAYOUT
DIMENSIONAL TOLERANCE: .XX ±0.05[0.002]

NOTES:

- MATERIALS:
HOUSING -PA446 POLYESTER UL94V-0
MIXED GLASS FIBER.
STANDARD COLOR-BLACK.
CONTACTS -0.35mm THICK PHOS-BRONZE PLATED
WITH 30U'MIN GOLD AND 100U' MIN TIN
PLATING ON SOLDER AREA.
SHIELD - C2680 T=0.20mm
30u"MIN. NICKEL UNDERPLATING ALL AREA
AND 100U' MIN TIN ON SOLDER AREA.
- CAVITY CONFIRMS TO FCC RULES AND REGULATIONS
PART 68,500 SUBPART F.
IEC 60603-7
- Electronic Properties Reference IEEE802.3
- Operating Temperature : -40°C TO 85°C
- Storage Temperature : 0°C TO 70°C

 东莞市涪程电子科技有限公司
DONG GUAN FU CHENG ELECTRONIC TECHNOLOGY Co., LTD

TITLE:	SIZE	UNITS	GENERAL TOLERANCES		APPROVED BY:
RJ45, CONNECTORS, W/O LED 10G+POE FILTER	A4	MM[INCH]	UNLESS SPECIFIED		JP.Gong
PART NO.:	SACLE	REV	x±0.35	x°±3.0°	CHECKED BY:
FTC-EA20-68P4	1:1	A0	.x±0.30	.x°±2.0°	TW.Xu
REMARK:	SHEET		.xx±0.25	.xx°±1.5°	DESIGND BY:
	1/3		.xxx±0.10	.xxx°±1.0°	MQ.Qu