

REACH & RoHS  
COMPLIANT

REV.	ECN / DESCRIPTION	BY	DATE
A0	NEW	MQ.Qu	2018.05.21

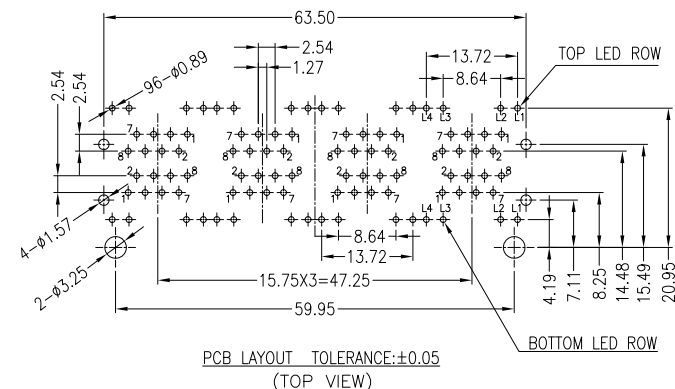

RECOMMENDED  
PANEL CUTOUT DIMENSION

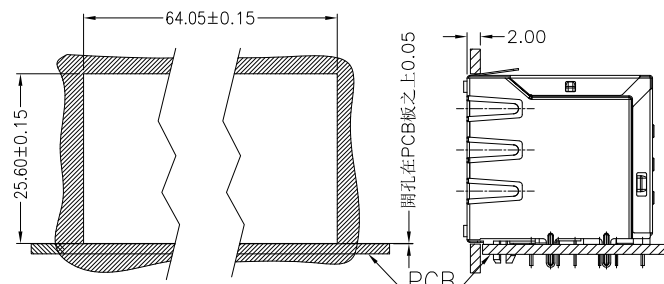
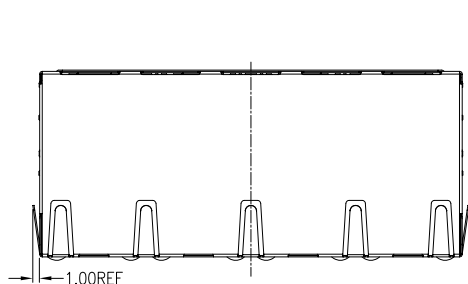
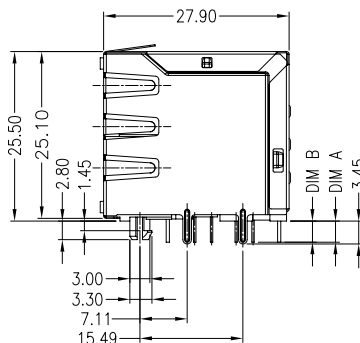
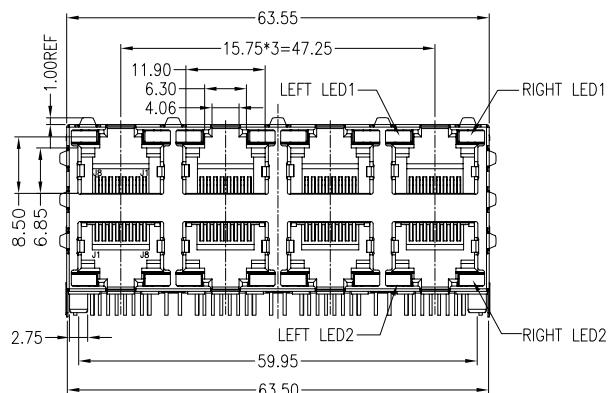

LED SCHEMATIC:

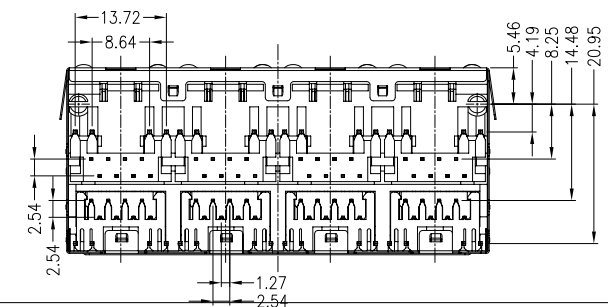
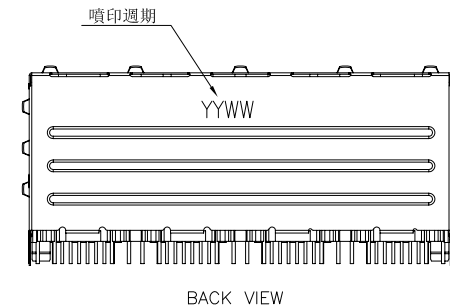
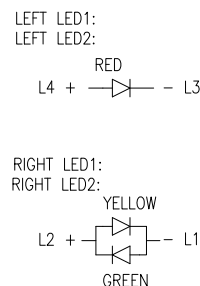

- NOTES:  
 1.MATERIAL:  
 HOUSING:HIGH TEMP.THERMOPLASTIC,BLACK,UL 94V-0  
 CONTACT:PHOSPHOR BRONZE,T=0.35mm.  
 SHELL:BRASS  
 2.FINISH:  
 CONTACT:50u"MIN. NICKEL UNDERPLATING ALL AREA,  
 100u"MIN. TIN ON SOLDERTAILS,  
 SELECT GOLD PLATING ON CONTACT AREA.  
 3.OPERATING TEMPERATURE:-40C~+85C.  
 4.JACK CAVITY CONFORMS TO FCC RULES AND  
 REGULATIONS PART 68, SUBPART F

P/N RULE:

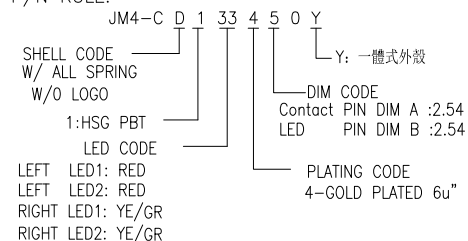

TITLE:	SIZE	UNITS	GENERAL TOLERANCES		APPROVED BY:
RJ45 CONNECTOR JM 2*4 PORT W/ LED, 8P8C, Shielded	A4	MM[INCH]	UNLESS SPECIFIED		JP.Gong
PART NO.:	SACLE	REV	x±0.35	x°±3.0°	CHECKED BY:
JM4-CD133450Y	1:1	A0	.x±0.30	.x°±2.0°	TW.Xu
REMARK:	SHEET		.xx±0.25	.xx°±1.5°	DESIGN BY:
	1/3		.xxx±0.10	.xxx°±1.0°	MQ.Qu



东莞市涪程电子科技有限公司  
DONG GUAN FU CHENG ELECTRONIC TECHNOLOGY Co., LTD

REACH & RoHS  
COMPLIANT

REV.	ECN / DESCRIPTION	BY	DATE
A0	NEW	MQ.Qu	2018.05.21

## Можно сделать с подвесными LED

Number	LEFT LED		RIGHT LED		Number	LEFT LED		RIGHT LED		Number	LEFT LED		RIGHT LED		Number	LEFT LED		RIGHT LED	
	L4+ L3-	L4- L3+	L2+ L1-	L2- L1+		L4+ L3-	L4- L3+	L2+ L1-	L2- L1+		L4+ L3-	L4- L3+	L2+ L1-	L2- L1+		L4+ L3-	L4- L3+	L2+ L1-	L2- L1+
1	YELLOW		GREEN		N	GREEN	ORANGE	YELLOW		21	GREEN				41	BLUE		BLUE	
2	YELLOW			GREEN	P	ORANGE	GREEN		YELLOW	22	GREEN	ORANGE	ORANGE		42	RED		RED	
3	GREEN			YELLOW	Q	ORANGE	GREEN	YELLOW		23	GREEN	YELLOW		GREEN	99	RED		YELLOW	
4	GREEN		YELLOW		R	GREEN		GREEN	ORANGE	24	GREEN	YELLOW	YELLOW		43		GREEN		ORANGE
5	GREEN		GREEN		S	YELLOW	GREEN	GREEN		25	ORANGE	GREEN	ORANGE	GREEN	44	WHITE		WHITE	
6	YELLOW		YELLOW		T	GREEN		ORANGE		26	上层YELLOW(极性L4+ L3-), 下层(极性L2+ L1-) 车板26专用				45	WHITE		GREEN	YELLOW
7		GREEN		YELLOW	U	GREEN	ORANGE	GREEN		27	GREEN	AMBER	GREEN		46	GREEN	AMBER	GREEN	AMBER
8	YELLOW	GREEN	YELLOW	GREEN	V		GREEN	YELLOW	ORANGE	28	YELLOW		YELLOW	GREEN	47		GREEN	GREEN	
9		GREEN	YELLOW		W	YELLOW			ORANGE	29	GREEN		YELLOW	GREEN	48		RED		GREEN
A	GREEN	YELLOW	GREEN	YELLOW	Y	YELLOW		ORANGE	GREEN	30	ORANGE	GREEN		GREEN	49	ORANGE		YELLOW	
A1	GREEN 525±5 nm	YELLOW 590±5 nm	GREEN 525±5 nm	YELLOW 590±5 nm	11	ORANGE		GREEN		31	YELLOW		GREEN	YELLOW	50		GREEN		
B	YELLOW		GREEN	ORANGE	12	ORANGE	YELLOW	GREEN		32	BLUE		GREEN		51	GREEN	RED	YELLOW	GREEN
C	ORANGE	YELLOW		GREEN	13	BLUE	YELLOW			33	RED		YELLOW	GREEN	52	GREEN	YELLOW	ORANGE	
D	GREEN		GREEN	YELLOW	14	GREEN		BLUE	YELLOW	34		GREEN	YELLOW	GREEN	53	YELLOW		ORANGE	
G	GREEN	ORANGE	GREEN	ORANGE	15			BLUE	YELLOW	35	AMBER	GREEN	AMBER	GREEN	54	RED		GREEN	
H	GREEN	YELLOW	GREEN		16			GREEN		36		GREEN		GREEN	55	GREEN		ORANGE	GREEN
J		YELLOW	ORANGE	GREEN	17	GREEN		AMBER		37	RED	GREEN	RED	GREEN					
K	GREEN		RED		18	GREEN	YELLOW			38		ORANGE		ORANGE					
L		YELLOW		GREEN	19	GREEN	YELLOW	GREEN	ORANGE	39	GREEN	ORANGE							
M		AMBER		GREEN	20	AMBER		GREEN		40	YELLOW	GREEN							



东莞市涪程电子科技有限公司  
DONG GUAN FU CHENG ELECTRONIC TECHNOLOGY Co., LTD

TITLE: RJ45 CONNECTOR JM 2\*4 PORT  
W/ LED, 8P8C, Shielded

PART NO.: JM4-CD133450Y

REMARK:

SIZE  
A4

SACLE  
1:1

SHEET  
1/3

UNITS  
MM[INCH]

REV  
A0

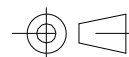

GENERAL TOLERANCES  
UNLESS SPECIFIED

$x \pm 0.35$   
 $x \pm 0.30$

$.xx \pm 0.25$   
 $.xxx \pm 0.10$

$x^\circ \pm 3.0^\circ$   
 $.x^\circ \pm 2.0^\circ$

$.xx^\circ \pm 1.5^\circ$   
 $.xxx^\circ \pm 1.0^\circ$

APPROVED BY:  
JP.Gong

CHECKED BY:  
TW.Xu

DESIGND BY:  
MQ.Qu