

REACH & RoHS  
COMPLIANT

REV.	ECN / DESCRIPTION	BY	DATE
A0	NEW	MQ.Qu	2018.05.21

LED SCHEMATIC:

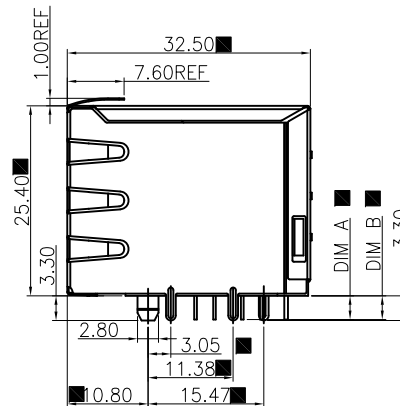
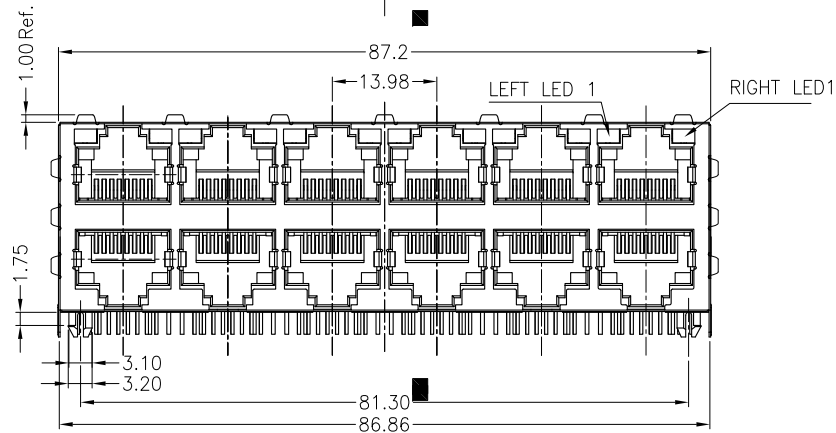
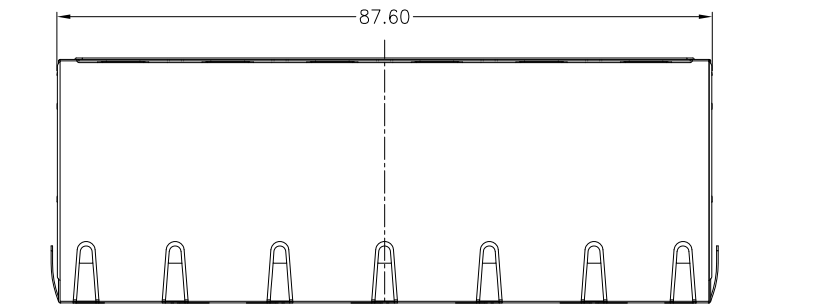
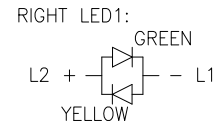
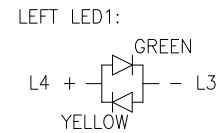

NOTES:

1.MATERIAL:

HOUSING:HIGH TEMP.THERMOPLASTIC,BLACK,UL 94V-0 (HF)  
CONTACT:PHOSPHOR BRONZE,T=0.35mm.  
SHELL:Brass,T=0.20mm

2.FINISH:

CONTACT:50u"MIN. NICKEL UNDERPLATING ALL AREA,  
100u"MIN. TIN ON SOLDER TAILS,  
GOLD PLATING ON CONTACT .

SHELL:30u"MIN. NICKEL UNDERPLATING ALL AREA

3.OPERATING TEMPERATURE:-40°C~+85°C.

4.JACK CAVITY CONFORMS TO FCC RULES AND  
REGULATIONS PART 68, SUBPART F

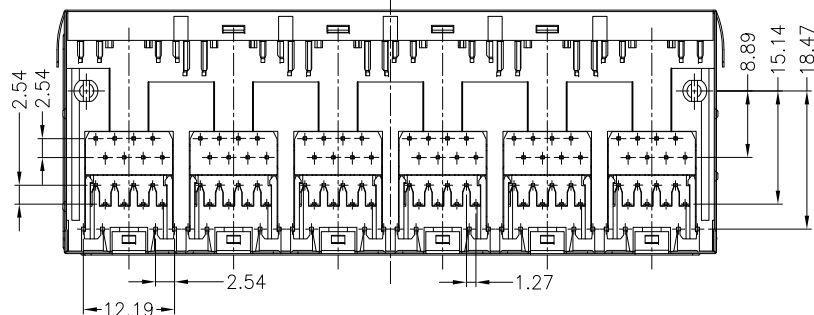

<p><b>TITLE:</b> RJ45 CONNECTOR JMA 2*6 PORT W/LED, 8P8C, Shielded</p>	<p><b>SIZE</b> A4</p>	<p><b>UNITS</b> MM[INCH]</p>	<p><b>GENERAL TOLERANCES</b> UNLESS SPECIFIED</p>		<p><b>APPROVED BY:</b> JP.Gong</p>				
			<p><b>PART NO.:</b> JMA-CDA4-461A</p>	<p><b>SACLE</b> 1:1</p>		<p><b>REV</b> A0</p>	$x \pm 0.35$	$x^\circ \pm 3.0^\circ$	<p><b>CHECKED BY:</b> TW.Xu</p>
							$.x \pm 0.30$	$.x^\circ \pm 2.0^\circ$	
<p><b>REMARK:</b></p>	<p><b>SHEET</b> 1/3</p>		$.xx \pm 0.25$	$.xx^\circ \pm 1.5^\circ$	<p><b>DESIGN BY:</b> MQ.Qu</p>				
			$.xxx \pm 0.10$	$.xxx^\circ \pm 1.0^\circ$					



东莞市涪程电子科技有限公司  
DONG GUAN FU CHENG ELECTRONIC TECHNOLOGY Co., LTD

REACH & RoHS  
COMPLIANT

REV.	ECN / DESCRIPTION	BY	DATE
A0	NEW	MQ.Qu	2018.05.21

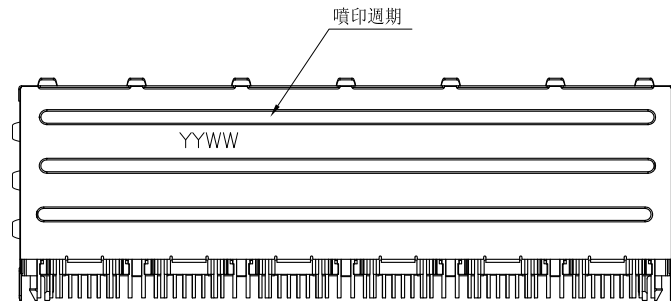

BACK VIEW

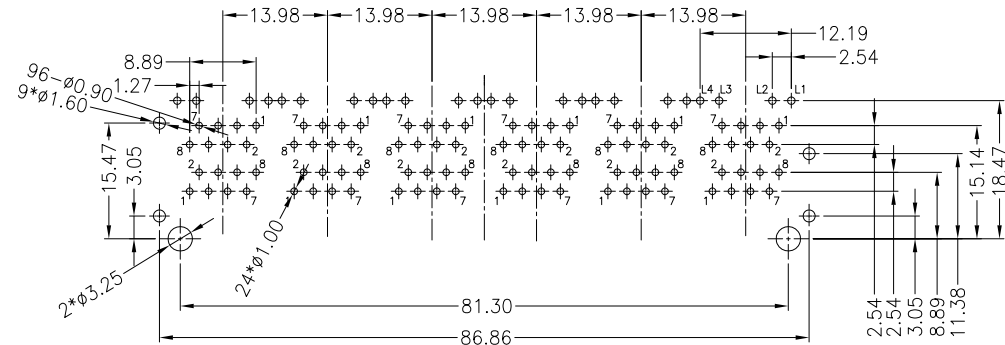

PCB LAYOUT TOLERANCE:±0.05

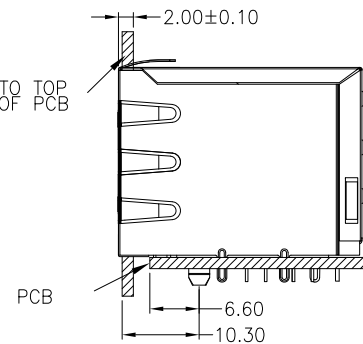
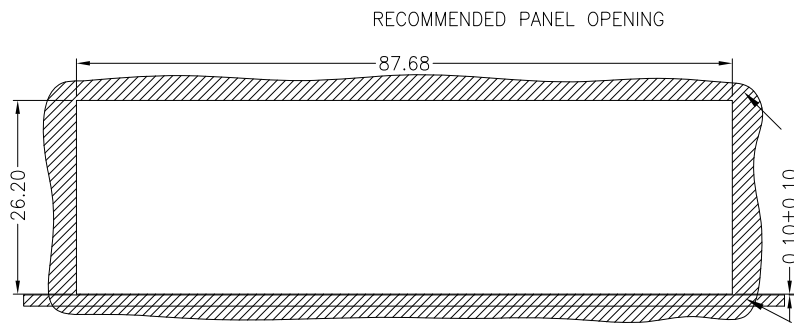

P/N RULE:

JMA-C D A A -4 6 1 A  
 SHELL CODE ————  
 D:W/ALL SPRING  
 W/O LOGO  
 W/O BACK LEG  
 A:PBT(无卤)  
 LED CODE ————  
 LEFT LED1: GR/YE  
 RIGHT LED1: GR/YE

A: 上層有燈, 下層無燈  
 1: 外殼C2680  
 DIM CODE  
 Contact PIN DIM A :3.18  
 LED PIN DIM B :3.18  
 PLATING CODE  
 4-GOLD PLATED 6u"

 东莞市涪程电子科技有限公司  
 DONG GUAN FU CHENG ELECTRONIC TECHNOLOGY Co., LTD

TITLE: RJ45 CONNECTOR JMA 2*6 PORT W/LED, 8P8C, Shielded	SIZE A4	UNITS MM[INCH]	GENERAL TOLERANCES UNLESS SPECIFIED		APPROVED BY: JP.Gong
PART NO.: JMA-CDAA-461A	SACLE 1:1	REV A0	x±0.35	x°±3.0°	CHECKED BY: TW.Xu
REMARK:	SHEET 1/3		.x±0.30	.x°±2.0°	DESIGND BY: MQ.Qu
			.xx±0.25	.xx°±1.5°	
			.xxx±0.10	.xxx°±1.0°	

REACH & RoHS  
COMPLIANT

REV.	ECN / DESCRIPTION	BY	DATE
A0	NEW	MQ.Qu	2018.05.21

## Можно сделать с подвесными LED

Number	LEFT LED		RIGHT LED		Number	LEFT LED		RIGHT LED		Number	LEFT LED		RIGHT LED		Number	LEFT LED		RIGHT LED	
	L4+ L3-	L4- L3+	L2+ L1-	L2- L1+		L4+ L3-	L4- L3+	L2+ L1-	L2- L1+		L4+ L3-	L4- L3+	L2+ L1-	L2- L1+		L4+ L3-	L4- L3+	L2+ L1-	L2- L1+
1	YELLOW		GREEN		N	GREEN	ORANGE	YELLOW		21	GREEN				41	BLUE		BLUE	
2	YELLOW			GREEN	P	ORANGE	GREEN		YELLOW	22	GREEN	ORANGE	ORANGE		42	RED		RED	
3	GREEN			YELLOW	Q	ORANGE	GREEN	YELLOW		23	GREEN	YELLOW		GREEN	99	RED		YELLOW	
4	GREEN		YELLOW		R	GREEN		GREEN	ORANGE	24	GREEN	YELLOW	YELLOW		43		GREEN		ORANGE
5	GREEN		GREEN		S	YELLOW	GREEN	GREEN		25	ORANGE	GREEN	ORANGE	GREEN	44	WHITE		WHITE	
6	YELLOW		YELLOW		T	GREEN		ORANGE		26	上层YELLOW(极性L4+ L3-), 下层(极性L2+ L1-) 车板2X6专用				45	WHITE		GREEN	YELLOW
7		GREEN		YELLOW	U	GREEN	ORANGE	GREEN		27	GREEN	AMBER	GREEN		46	GREEN	AMBER	GREEN	AMBER
8	YELLOW	GREEN	YELLOW	GREEN	V		GREEN	YELLOW	ORANGE	28	YELLOW		YELLOW	GREEN	47		GREEN	GREEN	
9		GREEN	YELLOW		W	YELLOW			ORANGE	29	GREEN		YELLOW	GREEN	48		RED		GREEN
A	GREEN	YELLOW	GREEN	YELLOW	Y	YELLOW		ORANGE	GREEN	30	ORANGE	GREEN		GREEN	49	ORANGE		YELLOW	
A1	GREEN 525±5 nm	YELLOW 590±3 nm	GREEN 525±5 nm	YELLOW 590±3 nm	11	ORANGE		GREEN		31	YELLOW		GREEN	YELLOW	50		GREEN		
B	YELLOW		GREEN	ORANGE	12	ORANGE	YELLOW	GREEN		32	BLUE		GREEN		51	GREEN	RED	YELLOW	GREEN
C	ORANGE	YELLOW		GREEN	13	BLUE	YELLOW			33	RED		YELLOW	GREEN	52	GREEN	YELLOW	ORANGE	
D	GREEN		GREEN	YELLOW	14	GREEN		BLUE	YELLOW	34		GREEN	YELLOW	GREEN	53	YELLOW		ORANGE	
G	GREEN	ORANGE	GREEN	ORANGE	15			BLUE	YELLOW	35	AMBER	GREEN	AMBER	GREEN	54	RED		GREEN	
H	GREEN	YELLOW	GREEN		16			GREEN		36		GREEN		GREEN	55	GREEN		ORANGE	GREEN
J		YELLOW	ORANGE	GREEN	17	GREEN		AMBER		37	RED	GREEN	RED	GREEN					
K	GREEN		RED		18	GREEN	YELLOW			38		ORANGE		ORANGE					
L		YELLOW		GREEN	19	GREEN	YELLOW	GREEN	ORANGE	39	GREEN	ORANGE							
M		AMBER		GREEN	20	AMBER		GREEN		40	YELLOW	GREEN							



东莞市涪程电子科技有限公司  
DONG GUAN FU CHENG ELECTRONIC TECHNOLOGY Co., LTD

TITLE: RJ45 CONNECTOR JMA 2*6 PORT W/LED, 8P8C, Shielded	SIZE A4	UNITS MM[INCH]	GENERAL TOLERANCES UNLESS SPECIFIED		APPROVED BY: JP.Gong
PART NO.: JMA-CDA4-461A	SACLE 1:1	REV A0	x±0.35	x°±3.0°	CHECKED BY: TW.Xu
REMARK:	SHEET 1/3		.xx±0.25	.xx°±1.5°	DESIGND BY: MQ.Qu
			.xxx±0.10	.xxx°±1.0°	