

6

5

4

3

2

1

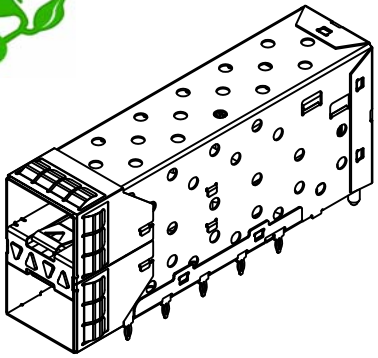

(4 LIGHT PIPE)  
E90-K110-4004

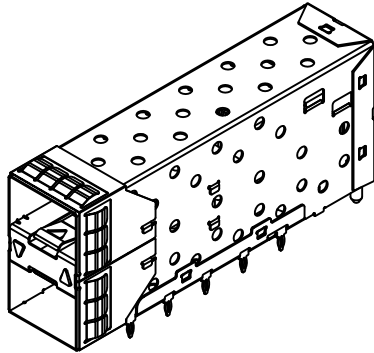

(2 OUTER LIGHT PIPE)  
E90-K110-4002

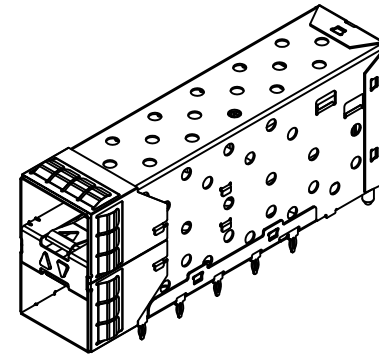

(2 INNER LIGHT PIPE)  
E90-K110-4003

PART NUMBER CONFIGURATION

E90-K110-400X

LIGHT PIPE OPTION

- 1 = 4 LIGHT PIPE
- 2 = 2 OUTER LIGHT PIPE
- 3 = 2 INNER LIGHT PIPE

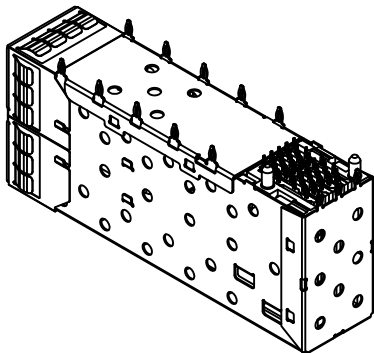

NOTES:

MATERIAL:

CAGE: NICKEL SILVER

CONNECTOR:

PLASTIC HOUSING: HIGH TEMPERATURE LCP, UL94 V-0.

LIGHT PIPE: POLYCARBONATE; COLOR: CLEAR

SPRING: STAINLESS STEEL

CONTACTS: PHOSPHOR BRONZE

CONTACT PLATING: 15u" MIN. GOLD ON MATING AREA,

150u" MATTE TIN ON SOLDER TAILS

PACKAGING: TRAY PACKAGING.

TEMPERATURE RANGE: -40°C TO +85°C

REV	ECN	LOCATIONS	DESCRIPTION	DATE	DESIGN	APVD
A	131031		PRODUCTION	2013.10.31	陈佐君	

DIMENSIONS ARE IN INCHES TOLERANCES UNLESS OTHERWISE SPECIFIED: X ± X.X ± 0.10 X.XX ± 0.05 X.XXX ± ANGLES ± 1°	APPROVALS	NAME	DATE	东莞市涪程电子科技有限公司 DONG GUAN FU CHENG ELECTRONIC TECHNOLOGY Co., LTD TITLE SFP+ 2X1 COMBO WITH LIGHT PIPE WITHOUT GROUNDING PIN
	DESIGNED	陈佐君	2013.10.31	
	CHECKED			
	APPROVED			
PROPRIETARY AND CONFIDENTIAL THE INFORMATION CONTAINED IN THIS DRAWING IS THE SOLE PROPERTY OF <YAEER ELECTRONICS>. ANY REPRODUCTION IN PART OR AS A WHOLE WITHOUT THE WRITTEN PERMISSION OF <YAEER ELECTRONICS> IS PROHIBITED.				SIZE
MATERIAL&FINISH: SEE NOTES				A
DO NOT SCALE DRAWING				DWG. NO.
SCALE: 1:1				E90-K110-400X
SHEET 1 OF 4				REV.
PRODUCTION DRAWING				A

6

5

4

3

2

1

6 5 4 3 2 1

REV	ECN	LOCATIONS	DESCRIPTION	DATE	DESIGN	APVD
A	131031		PRODUCTION	2013.10.31	陈佐君	

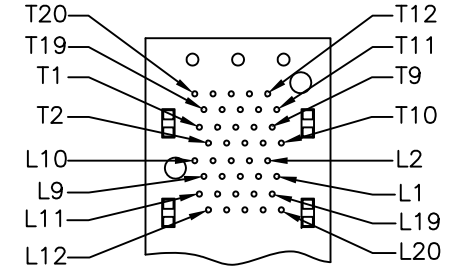
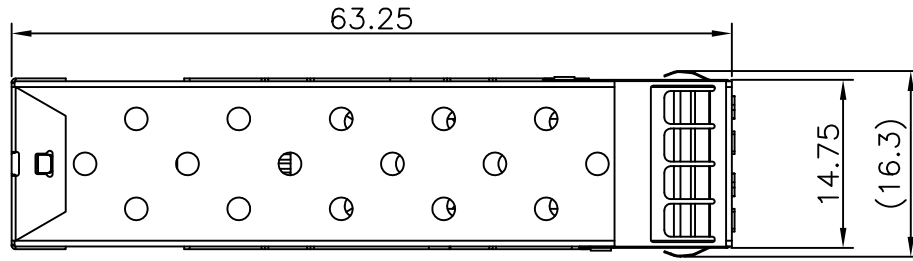

CONNECTOR PIN-OUT  
COMPONENT SIDE OF B

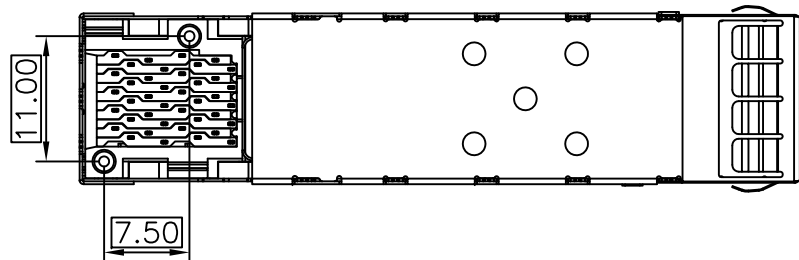
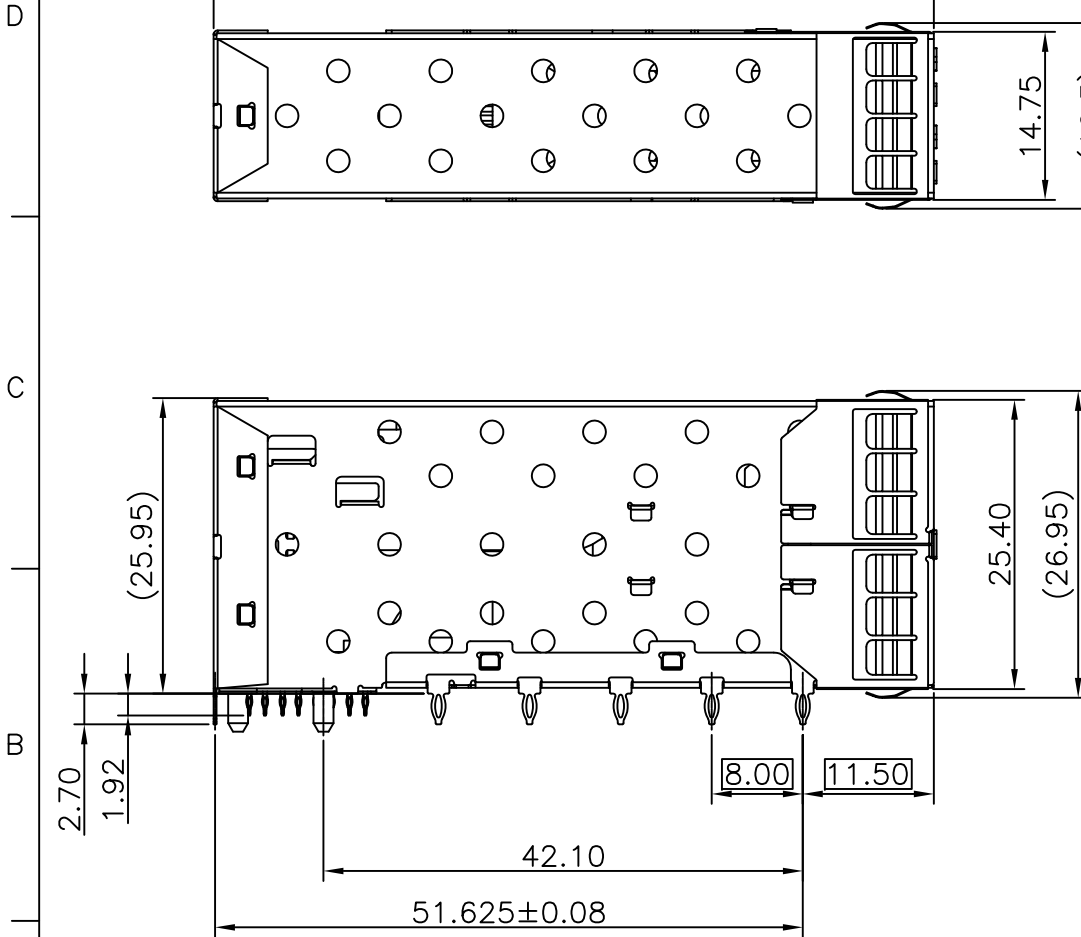
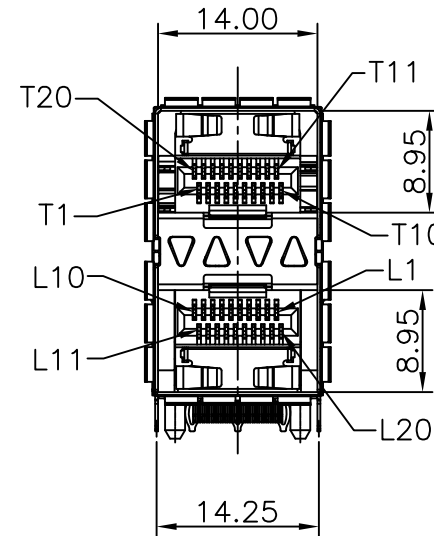

DIMENSIONS ARE IN INCHES TOLERANCES UNLESS OTHERWISE SPECIFIED: X ± X.X ± 0.10 X.XX ± 0.05 X.XXX ± ANGLES ± 1°	APPROVALS	NAME	DATE	东莞市浚程电子科技有限公司 DONG GUAN FU CHENG ELECTRONIC TECHNOLOGY Co., LTD TITLE SFP+ 2X1 COMBO WITH LIGHT PIPE WITHOUT GROUNDING PIN SIZE A DWG. NO. E90-K110-400X REV. A
	DESIGNED	陈佐君	2013.10.31	
	CHECKED			
	APPROVED			
PROPRIETARY AND CONFIDENTIAL THE INFORMATION CONTAINED IN THIS DRAWING IS THE SOLE PROPERTY OF <YAEER ELECTRONICS>. ANY REPRODUCTION IN PART OR AS A WHOLE WITHOUT THE WRITTEN PERMISSION OF <YAEER ELECTRONICS> IS PROHIBITED.				
MATERIAL&FINISH: SEE NOTES		DO NOT SCALE DRAWING		SCALE: 1:1 CUSTOMER DRAWING SHEET 2 OF 4

6 5 4 3 2 1

6 5 4 3 2 1

REV	ECN	LOCATIONS	DESCRIPTION	DATE	DESIGN	APVD
A	131031		PRODUCTION	2013.10.31	陈佐君	

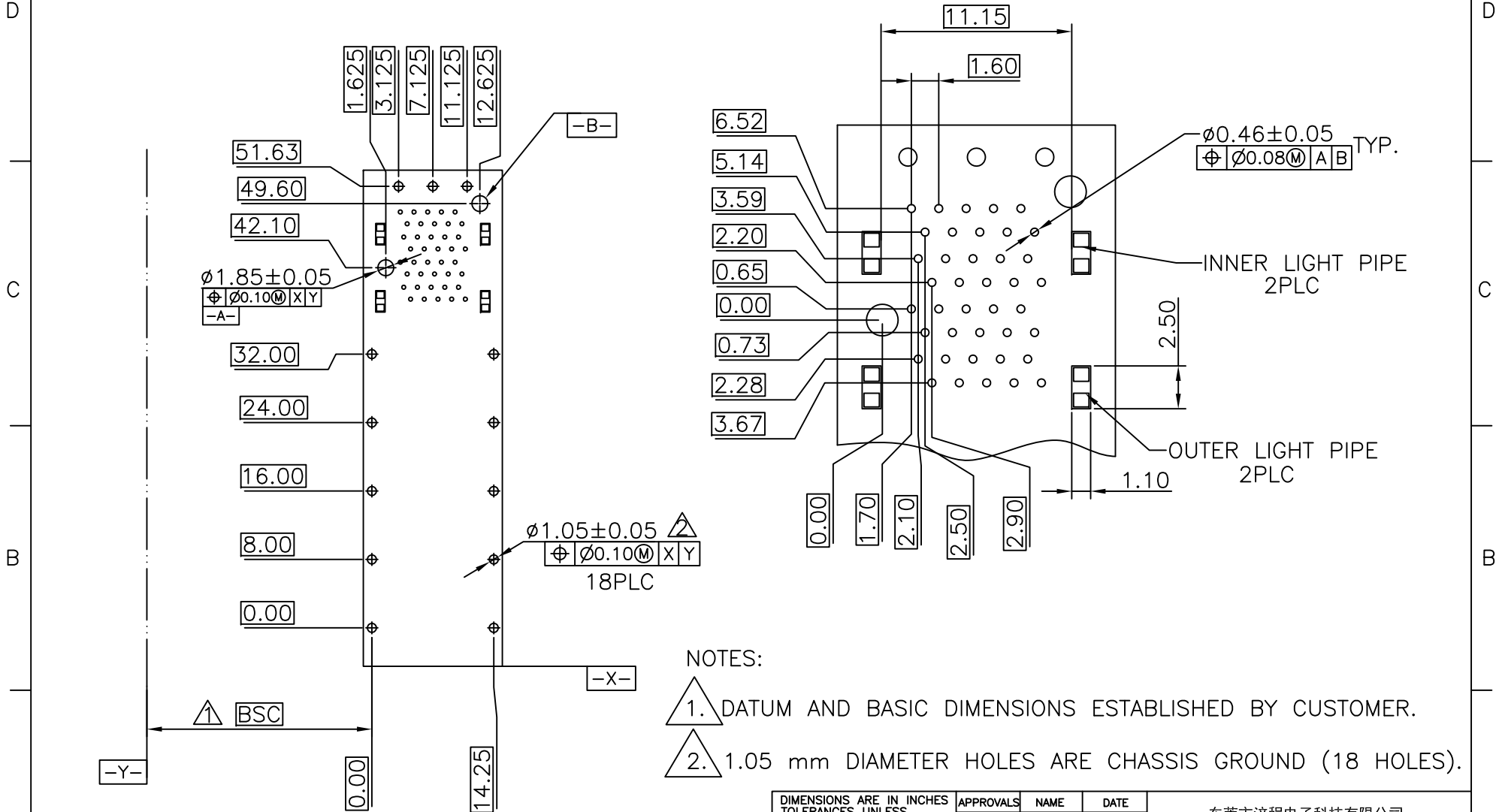

NOTES:

- DATUM AND BASIC DIMENSIONS ESTABLISHED BY CUSTOMER.
- 1.05 mm DIAMETER HOLES ARE CHASSIS GROUND (18 HOLES).

ECOMMENDED PCB CONFIGURATION

DIMENSIONS ARE IN INCHES TOLERANCES UNLESS OTHERWISE SPECIFIED: X.X           ++       0.10 X.XX          +++       0.05 X.XXX        +++       0.01 ANGLES       ++       1°	APPROVALS	NAME	DATE	东莞市涪程电子科技有限公司 DONG GUAN FU CHENG ELECTRONIC TECHNOLOGY Co., LTD TITLE SFP+ 2X1 COMBO WITH LIGHT PIPE WITHOUT GROUNDING PIN
	DESIGNED	陈佐君	2013.10.31	
	CHECKED			
	APPROVED			PROPRIETARY AND CONFIDENTIAL THE INFORMATION CONTAINED IN THIS DRAWING IS THE SOLE PROPERTY OF <YAEER ELECTRONICS>. ANY REPRODUCTION IN PART OR AS A WHOLE WITHOUT THE WRITTEN PERMISSION OF <YAEER ELECTRONICS> IS PROHIBITED.
MATERIAL&FINISH: SEE NOTES	DO NOT SCALE DRAWING	SCALE: 1:1	CUSTOMER DRAWING	SIZE A DWG. NO. E90-K110-400X REV. A
			SHEET 3 OF 4	

6 5 4 3 2 1

6 5 4 3 2 1

REV	ECN	LOCATIONS	DESCRIPTION	DATE	DESIGN	APVD
A	131031		PRODUCTION	2013.10.31	陈佐君	

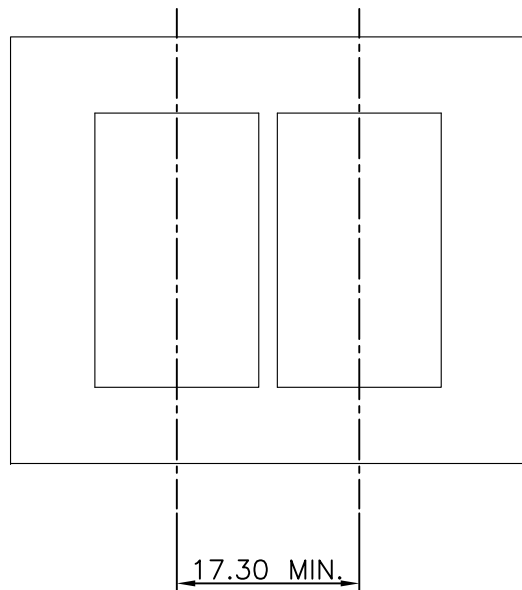
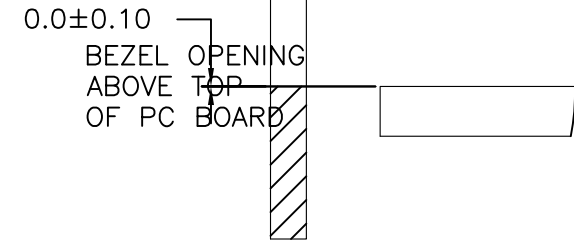
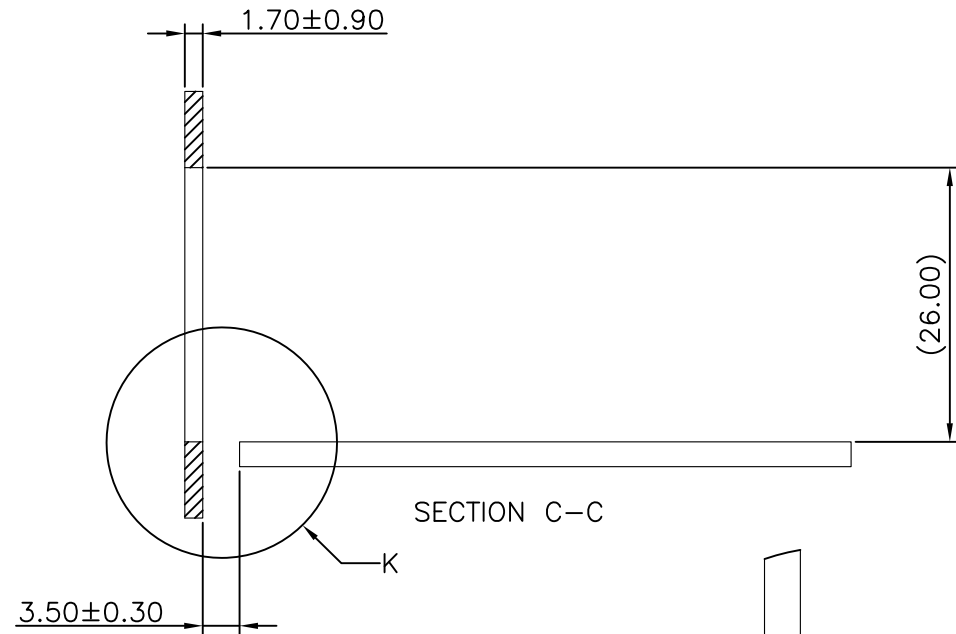
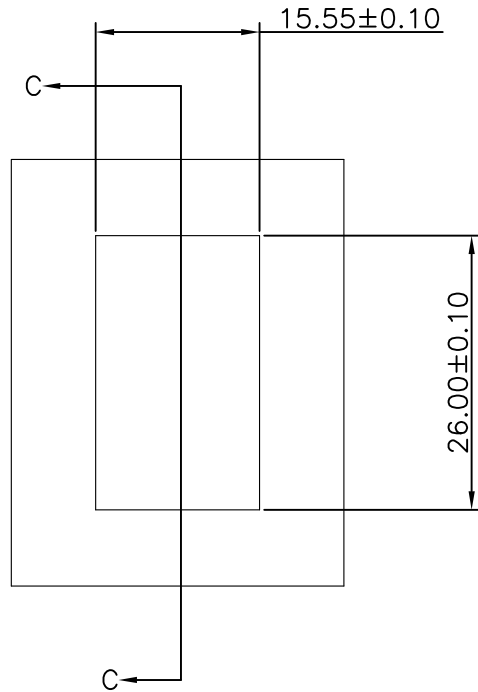

RECOMMENDED BEZEL DESIGN

DETAIL K  
2:1

DIMENSIONS ARE IN INCHES TOLERANCES UNLESS OTHERWISE SPECIFIED: X ± X.X ± 0.10 X.XX ± 0.05 X.XXX ± ANGLES ± 1°	APPROVALS	NAME	DATE	东莞市涪程电子科技有限公司 DONG GUAN FU CHENG ELECTRONIC TECHNOLOGY Co., LTD TITLE SFP+ 2X1 COMBO WITH LIGHT PIPE WITHOUT GROUNDING PIN SIZE A DWG. NO. E90-K110-400X REV. A
	DESIGNED	陈佐君	2013.10.31	
	CHECKED			
	APPROVED			
PROPRIETARY AND CONFIDENTIAL THE INFORMATION CONTAINED IN THIS DRAWING IS THE SOLE PROPERTY OF <YAEF ELECTRONICS>. ANY REPRODUCTION IN PART OR AS A WHOLE WITHOUT THE WRITTEN PERMISSION OF <YAEF ELECTRONICS> IS PROHIBITED.				
MATERIAL&FINISH: SEE NOTES		DO NOT SCALE DRAWING		SCALE: 1:1 CUSTOMER DRAWING SHEET 4 OF 4

D  
C  
B  
A

D  
C  
B  
A

6 5 4 3 2 1